











MONI 8814401

IP Rate: IP66
RGB+CCT Smart LED Garden Light
Model No.: 8814401

Features

-  RGB+CCT
16 Millions of colors to choose
-  Color temperature
2700~6500K
-  Dimmable
Saturation control
-  2.4G RF wireless transmission technology
-  Signal transmitting & Modes synchronization
-  Remote control
Control distance 30m
-  Smart phone App control
(2.4GHz gateway is needed)
-  Support third party voice control
(2.4GHz gateway is needed)
-  Waterproof and dustproof grade IP66
-  Beam Angle 15°
Illumination distance Greater than 10m

Parameters

Model No.	FUTC01
Input Voltage	AC/DC 12V
Power	9W
Working Temp.	-20~60°C
Color temp.	2700K~6500K
Luminous Flux	900LM
Light Efficiency	100LM/W
CRI	>80
PF	—
Lifespan	50000 hours
Beam Angle	15°
Illumination distance	>10m
IP Rate	IP66
RF	2.4GHz
Control Distance	30m

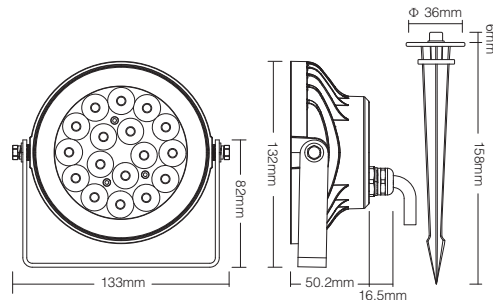

Signal transmitting

One lighting fixture can transmit the signals from the remote control to another lighting fixture within 30m, as long as there is a lighting fixture within 30m, the remote control distance can be limitless.

Modes synchronization

Different lighting fixture can work synchronously when they are started at different times, controlled by the same remote, under same dynamic mode and within 30m distance.

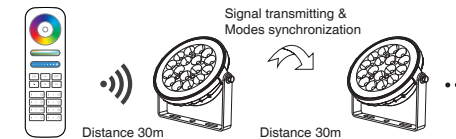

Connection diagram

Input Voltage DC 24V, don't need to distinguish polarity on the connection

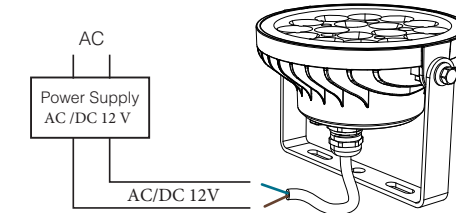

Link/Unlink

Compatible with these remote controls (Purchased separately)



8814403



8814404 WiFi Bridge



Lighting can be working after linking with remote; for more details, pls read the remote instruction.

